



FAGOR AUTOMATION

Digital readouts





Fagor Automation in permanent evolution

Fagor Automation has been manufacturing digital readouts for over 30 years and has always kept ahead launching innovative products adapted to the actual machining requirements of conventional machines. This catalog is proof of that completing the DRO range with models that provide new and exclusive features.

With solutions for each machine

Innova series FAGOR DRO's carry components created, developed and patented by Fagor Automation. Highly reliable products that adapt to the customers' particular needs in order to improve the productivity of milling machines, boring mills, lathes, grinders, EDM and general purpose applications among other machines.

- For milling machines and boring mills **M series**
- For lathes **T series**
- For EDM and grinders **E series**
- For general purpose applications **General series**

With exclusive features

The design of Fagor Automation's 40i DRO models differs from the rest in that they have a 5.7" color TFT screen that offers a better view from any angle. They also include graphic programming assistance and 3D simulation providing intuitive and friendly operation.

With state-of-the-art technology

The DRO offers the user features that make his job easier, but what sets it apart in terms of machining accuracy is the feedback installed on the axes of the machine.

Fagor Automation uses high quality, highly reliable optic technology to manufacture their linear and rotary encoders.

This results in a variety of feedback products that includes the recent absolute linear encoders whose protocols are compatible with the most relevant CNC manufacturers on the market.

Linear and rotary encoders ideal for conventional machines

Linear	Measuring lengths	Accuracy
F series	440 mm to 30 m	$\pm 5 \mu\text{m/m}$
C series	220 mm to 3040 mm	$\pm 5 \mu\text{m/m}$ / $\pm 10 \mu\text{m/m}$
M series	40 mm to 1540 mm	$\pm 5 \mu\text{m/m}$ / $\pm 10 \mu\text{m/m}$
MM series	40 mm to 520 mm	$\pm 5 \mu\text{m/m}$ / $\pm 10 \mu\text{m/m}$

Rotary	Pulses/turn	Accuracy
H, HP series	Up to 3.000	$\pm 1/10$ of the pitch
S, SP series	Up to 5.000	$\pm 1/10$ of the pitch
HA series	Up to 10.000	$\pm 1/10$ of the pitch

Accuracy certificate

All FAGOR linear feedback systems are subjected a final accuracy test carried out on a computerized measuring bench equipped with a laser interferometer inside a climate-controlled chamber at a temperature of 20 °C (68 °F).

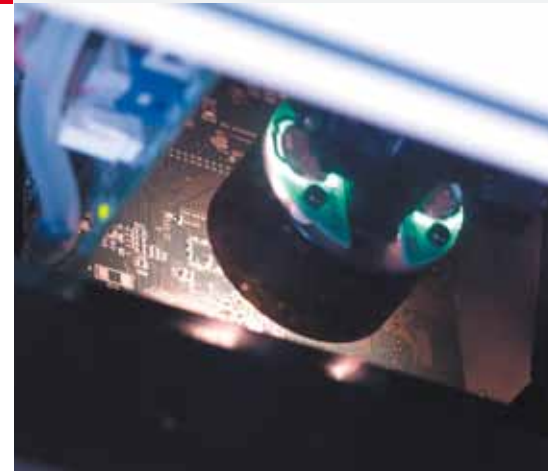

M series

2, 3 and 4 axes

40i P model



40i model



Specific characteristics: 40i

Using the TFT screen of the Innova 40i, it is possible to select the X, Y, Z plane where the machining will take place, graphically see the steps to follow and simulate the end result in 3D.

All that in the intuitive and friendly way that only FAGOR can offer.

Graphic programming assistance:

- Bolt-hole drilling
- Linear drilling
- Grid pattern drilling
- Angle calculation in the plane

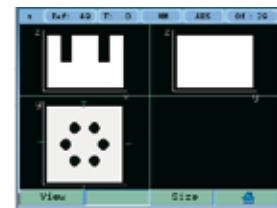
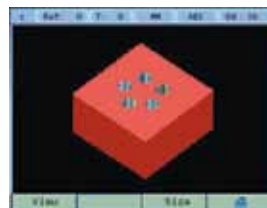

40i P model

The 40i P model includes the following features:

- Part-program programming and backup
- X, Y, Z, W machining plane selection
- Up to 4 feedback axes and display on the main screen
- Independent linear and angular feedback, 4-axis display, slope of each axis
- Probe

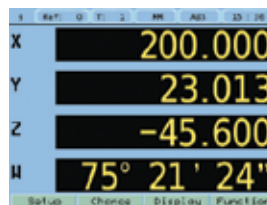

30i M model

20i M model



Common characteristics, M series

Bolt-hole drilling

The position of the holes is calculated automatically by entering the values requested by the DRO.

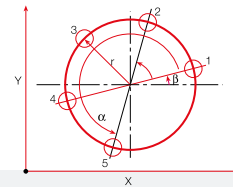

Linear drilling calculation

Calculates, memorizes the position and guides through the execution of linear drilling operations at any angle with respect to the axes.

Tool radius compensation

The tool radius is added to or subtracted from the position value when milling with a round tool depending on the machining direction.

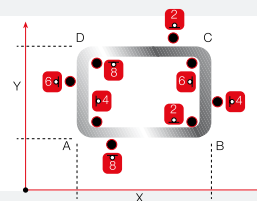

Corner rounding/machining of arcs

To be used in simple corner rounding or curved surfaces in a plane defined by two linear axes.

Part centering

Simply touching two points of the part with the tool or with a probe and pressing a key, the DRO calculates the center of the part.

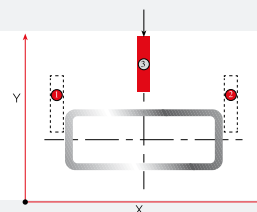

Part alignment

For measuring angles avoiding part misalignment and correct its inclination until the right position is obtained.

Multiple part-zeros (datum points)

It makes working with several origin points easier and may be used to save tool data and to position holes.

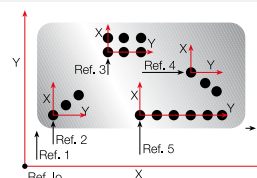

T series

2, 3 and 4 axes

40i TS model



40i model



Specific characteristics: 40i

The Innova 40i for lathes offers the operator graphic assistance that no other DRO can offer to program turning operations friendly and intuitively.

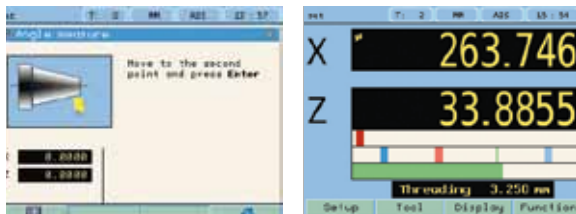

Graphic programming and operating assistance:

- Part taper calculation
- Axis coupling
- Easy threading even for mixed threads with leadscrews and threads in different units (mm/inch)

40i TS model

This dro calculates and automatically varies the spindle speed according to the X axis radius while machining; thus providing optimum part finish, machining time saving and longer tool life.

Its main characteristics:

- Constant Surface Speed (CSS)
- Spindle orientation with Teach-in
- Override (50-150%) of the programmed RPM without interrupting the machining operation
- Spindle speed control through an external potentiometer
- Display of real RPM



And for the machine integrator:

- Up to 4 spindle speed ranges (gears)
- Special inputs: Emergency input, analog input for the potentiometer, external push buttons (M3, M4, Stop, etc.)
- Analog and digital outputs
- It admits an encoder at the spindle

30i T model



20i T model



Common characteristics, T series

Taper calculation

The taper of a part may be calculated by entering the value of two points of the travel at the DRO.

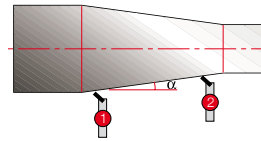

Z axis coupling

A parallel axis may be coupled with its pair at the same DRO display axis showing the combination of both on the Z axis display.

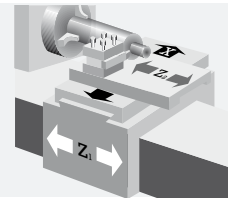

Up to 100 tool references

When using more than one tool, each one will have a different origin (offset), these origins may be saved and recalled every time a new tool is changed. At every tool change, it saves a different origin (offset) that may be recalled by the operator.

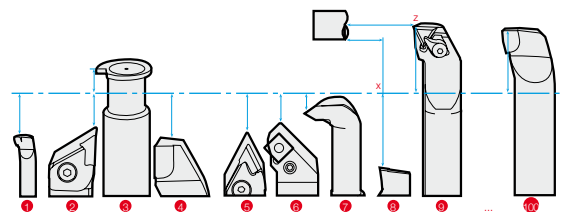

Preset in HOLD mode

It is possible to preset on the axis the actual diameter value of the machined part (measured with a caliper or a micrometer).

E series

1, 2 and 3 axes

30i E model



20i E model



10i E model



Common characteristics, E series

EDM mode: to set the activation level of the EDM program. Any level may be changed even during the EDM process.

6 digital outputs

To control up to 6 penetration levels.

4 digital inputs

For axis zero setting and emergency input.

Electrode length compensation

The outputs may be disabled during the EDM operation for measuring or replacing the electrode.

30i E model

The 30i E model includes the following features:

- Bolt-hole drilling
- Linear drilling
- Hold

General series

40i model



20i model



10i model



Common characteristics, General series

These models provide multi-purpose solutions, because they may be adapted to applications as different as auxiliary axes, metrology, woodworking machines, etc.

General specifications of all Fagor Automation DRO's

■ **Preset function**

For the operator to enter values into the DRO and save them in its memory and recall them when needed.

■ **Axis coupling**

Parallel axes may be combined so a single axis display shows the addition/subtraction of both axes.

■ **Easy setup**

The DRO detects the characteristics of the feedback system to which it is connected and sets its internal parameters automatically.

■ **Multi-point compensation**

Its 100 compensation points provide maximum efficiency and guarantee absolute precision. This point-to-point compensation minimizes possible machine errors.

■ **Display of maximum, minimum coordinates and the difference between them**

■ **Fine or coarse resolution, as needed**

■ **Connection to linear and angular axes**

■ **Software travel limits**

These limits do not cancel the ones already set by the travel limits of the machine, but offer the operator the chance to add other limits between the main ones.

■ **40i models: USB connection**

USB connection for uploading/downloading data from/to a PC or pendrive.

■ **40i models: Innova DRO**

Also, the Innova 40i offers the operator the advantage of working with a color TFT screen.

Comparison table

	M series milling machines and boring mills				T series lathes				E series EDM and grinders			General series general purpose applications		
	40i P	40i	30i M	20i M	40i TS	40i	30i T	20i T	30i E	20i E	10i E	40i	20i	10i
feedback														
connection to 1 Vpp and SSI encoders	4	3			4	3						3		
connection to TTL encoders	4	3	3	3	4	3	3	2	3	2	1	3	2	1
linear axes	•	•	•	•	•	•	•	•	•	•	•	•	•	•
angular encoders	•	•	•	•					•	•	•	•	•	•
incremental and distance-coded reference marks	•	•	•	•	•	•	•	•	•	•	•	•	•	•
linear axis sag compensation	•	•	•	•	•	•	•	•	•	•	•	•	•	•
multi-point compensation (points per axis)	100	100	40	40	100	100	40	40	40	40	40	100	40	40
1 Vpp signal monitoring	•	•			•	•						•		
travel limit alarm	•	•	•	•	•	•	•	•	•	•	•	•	•	•
display														
5.7" color TFT screen	•	•			•	•						•		
LED display			•	•			•	•	•	•	•		•	•
number of axes	4	3	3	2	4	3	3	2	3	2	1	3	2	1
radius or diameter display	•	•	•	•	•	•	•	•				•	•	•
mm/inch conversion	•	•	•	•	•	•	•	•	•	•	•	•	•	•
fine / coarse resolution	•	•	•	•	•	•	•	•	•	•	•	•	•	•
absolute / incremental feedback	•	•	•	•	•	•	•	•	•	•	•	•	•	•
"display off" mode	•	•	•	•	•	•	•	•	•	•	•	•	•	•
axis coupling	•	•	•	•	•	•	•	•	•	•		•	•	
functions														
zero setting of the axes	•	•	•	•	•	•	•	•	•	•	•	•	•	•
buzzer function	•	•	•	•	•	•	•	•	•			•		
number of references - part zeros	100	100	20	20					20	20	20	100		
number of tools	16	16			100	100	20	20				16/100		
axis preset	•	•	•	•	•	•	•	•	•	•	•	•	•	•
tool compensation	•	•	•	•					•	•	•	•		
axis feedrate display	•	•			•	•	•					•		
calculator	•	•	•	•	•	•	•	•	•			•		
easy setup	•	•	•	•	•	•	•	•	•	•	•	•	•	•
electrode length compensation									•	•	•			
hysteresis factor			•	•			•	•	•	•	•		•	•
cycles														
part centering cycles	•	•	•	•					•	•	•	•	•	•
bolt hole drilling (with the most recent data saved in memory)	•	•	•	•					•			•		
linear drilling	•	•	•	•					•			•		
grid pattern drilling	•	•										•		
EDM mode									•	•	•			
corner rounding / machining of arcs			•	•					•					
go to a particular position	•	•				•						•		
angle measuring	•	•	•	•					•			•		
taper calculation					•	•	•	•				•		
turning					•	•						•		
facing					•	•						•		
assisted threading (easy threading)						•						•		
on-screen guided help, with graphics	•	•			•	•						•		
storage of many part-programs	•													
others														
USB connection for copying data	•	•			•	•						•		
auto shut-off after 30-minute idle	•	•	•	•	•	•	•	•	•	•	•	•	•	•
digital inputs / outputs					15/11				4/6	4/6	4/6			
analog inputs / outputs					1/1									
probe	•	•				•						•		

Accessories

Support arm



- For mill ARM 300 model, 300 mm long
ARM 500 model, 500 mm long



- For lathe ARM-V-500 model
500 mm long

Adapter plate



- For built-in model

Operating conditions

Power supply protected against AC mains outage

universal power supply with an input range between 85 VAC and 264 VAC. Frequency from 45 Hz to 400 Hz

Operating temperature

from 5 °C to 45 °C (from 41°F to 113 °F)

Storage temperature

from -25 °C to 70 °C (from -13 °F to 158 °F)

relative humidity

maximum 95% without condensation at 45 °C (113 °F)

Sealing

front panel IP54 and rear panel IP4X (DIN 40050)

Product in compliance with safety and electromagnetic compatibility regulations

EN-60204-1, EN-50081-2, EN 55011, EN-55022, EN-55082, EN- 610004-2, 3,4, 5,6,11. EN-V50140, EN-V50141, ENV 50204 and EC directives 73/23/ECC, 89/392/CEE, 89/336/ECC and 73/23/ECC

Type of feedback signals

TTL and differential TTL (EIA422).

Plus, 1 Vpp and SSI on the 40i models

Maximum feedback frequency

250 KHz

Dimensions in mm

10i, 20i, 30i models

Tabletop models

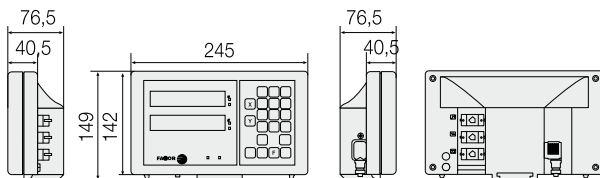

40i models

Tabletop models

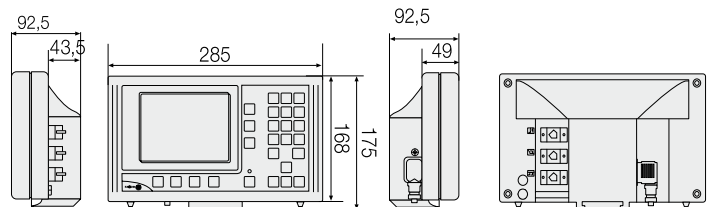

Built-in models

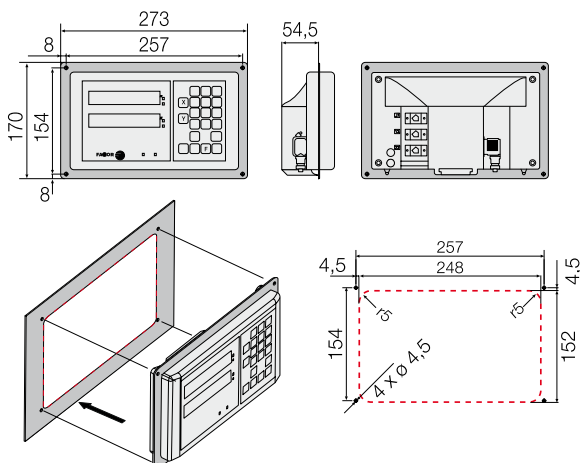

Built-in models

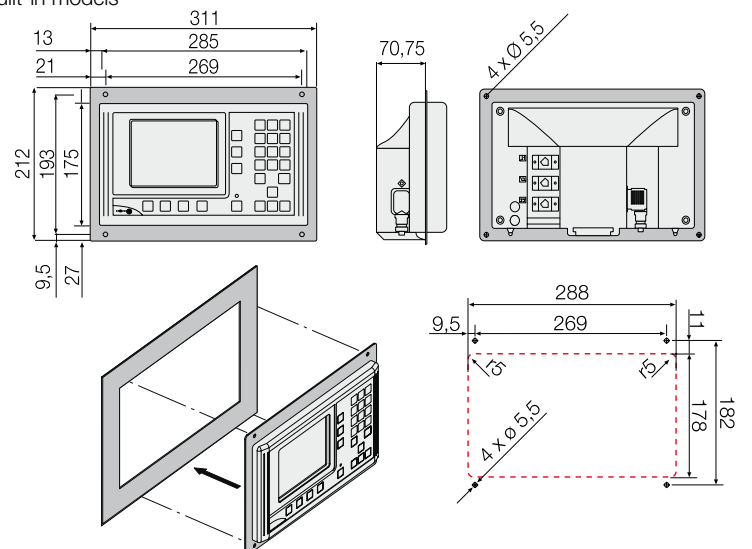

(*) Built-in option: Add "B" to the model (for example: 20i-B)

(*) Built-in option: Add "B" to the model (for example: 40i-B)



FAGOR AUTOMATION

Fagor Automation, S. Coop.

Bº San Andrés, 19
E-20500 Arrasate - Mondragón
SPAIN
Tel.: +34 943 719 200
Fax.: +34 943 791 712
E-mail: info@fagorautomation.es



Fagor Automation holds the ISO 9001
Quality System Certificate and the
CE Certificate for all products manufactured.

www.fagorautomation.com

FAGOR AUTOMATION shall not be held responsible for any printing or transcribing errors in this catalog and reserves the right to make any changes to the characteristics of its products without prior notice.

EPS - DRO EN 0312



worldwide automation